

# I SABELLA LX



10	RS TB
13	RS TB

**ISA S.r.l.**

Via del Lavoro, 5  
06083 Bastia Umbra - Perugia - Italy  
Tel. +39 075 80171 - Fax +39 075 8000900  
[www.isaitaly.com](http://www.isaitaly.com)



**I SABELLA LX**

**USE AND MAINTENANCE MANUAL**













428000085237

**ICE CREAM CABINETS**

<b>1.</b>	<b>MANUFACTURER</b>	<b>4</b>
<b>2.</b>	<b>WARRANTY TERMS AND CONDITIONS</b>	<b>4</b>
<b>3.</b>	<b>EQUIPMENT IDENTIFICATION</b>	<b>5</b>
<b>4.</b>	<b>USE</b>	<b>6</b>
4.1	COMPOSITION	6
<b>5.</b>	<b>NOTES / IMPORTANT NOTES</b>	<b>7</b>
<b>6.</b>	<b>SAFETY</b>	<b>9</b>
6.1	SAFETY DEVICES PRESENT	9
6.2	FIXED PROTECTIONS	9
6.3	ISOLATING THE ELECTRIC POWER SUPPLY	9
6.4	RESIDUAL RISKS	9
6.5	RISKS OF CONTACT WITH LIVE PARTS	9
6.6	FIRE	10
6.7	EXPLOSIVE ATMOSPHERE	10
6.8	SLIPPING	10
6.9	TRIPPING	10
6.10	CIRCUIT FAULTS	10
6.11	WARNING SIGNS (if any)	10
6.12	RISKS OF EXPLOSION	10
6.13	FALLING OBJECTS	10
6.14	COOLING	11
6.15	FOODSTUFFS SAFETY (PACKAGED PRODUCTS)	11
6.16	REFRIGERANTS (where applicable)	12
<b>7.</b>	<b>DISPOSAL OF WASTE MATERIAL</b>	<b>13</b>
<b>8.</b>	<b>INSTALLATION</b>	<b>14</b>
8.1	STORAGE AND UNPACKING	14
8.2	INSTALLATION - POSITIONING - ENVIRONMENTAL CONDITIONS	14
8.3	ELECTRIC CONNECTION	14
<b>9.</b>	<b>MAINTENANCE</b>	<b>15</b>
<b>10.</b>	<b>FAULTS - TECHNICAL AFTER-SALES ASSISTANCE</b>	<b>16</b>
10.1	ALARMS LIST (where present)	17
<b>11.</b>	<b>TECHNICAL SPECIFICATIONS</b>	<b>18</b>
11.1	CONTAINERS ARRANGEMENT ICE CREAM CONTAINERS	19
11.2	INSTALLATION	20
11.3	LOAD LIMITS	20
11.4	LIGHTING (LED)	20
11.5	POSITIONING	21
11.6	OPEN/CLOSE SELF ROLLING CURTAIN	22
<b>12.</b>	<b>CONTROL PANEL</b>	<b>23</b>
12.1	USER INTERFACE EW978	24
12.2	USER INTERFACE XR44CX	26
<b>13.</b>	<b>CLEANING</b>	<b>29</b>
<b>14.</b>	<b>PROLONGED APPLIANCE SWITCH-OFF</b>	<b>31</b>

Attachment 1	<b>DECLARATION OF CONFORMITY</b>	<b>32</b>
Attachment 2	<b>WIRING DIAGRAM - 412100046100</b>	<b>33</b>
Attachment 3	<b>WIRING DIAGRAM - 412100047100</b>	<b>34</b>
Attachment 4	<b>WIRING DIAGRAM - 412100427000</b>	<b>35</b>
Attachment 5	<b>WIRING DIAGRAM - 412100428000</b>	<b>36</b>
Attachment 6	<b>WIRING DIAGRAM - 412100430000</b>	<b>37</b>
Attachment 7	<b>WIRING DIAGRAM - 412100431000</b>	<b>38</b>
Attachment 8	<b>INSTALLATION BAR SUPPORT TRAYS 5 liters</b>	<b>39</b>
Attachment 9	<b>INSTALLATION BAR SUPPORT TRAYS 4.75 liters</b>	<b>40</b>

The manual contains symbols to attract the reader's attention and highlight particularly important aspects. The table below illustrates the meaning of the various symbols used.

	Read the instructions manual		Use of protective clothing
	Danger: Live electrical parts		Requests for maintenance or operations must be carried out by qualified staff or technical after-sales centres.
	Attention / Danger		Important information
	Information		Operations that must be performed by two persons.
	Visual observation		Notes / Important notes
	Condensing unit on board		Remote condensing unit

## 1. MANUFACTURER

### ISA S.r.l.

Via del Lavoro, 5  
06083 - Bastia Umbra - Perugia - Italy  
Tel. +39 075 80171  
Fax +39 075 8000900

[www.isaitaly.com](http://www.isaitaly.com)

## 2. WARRANTY TERMS AND CONDITIONS



The seller's warranty on the equipment is valid for **12 (TWELVE) months from the date of delivery.**

The warranty includes repairs or replacements of any faulty parts due to manufacturing processes or installation after written communication has been received, stating the appliance serial number and date of installation.

Not included in the warranty:

- all defects caused by incorrect use of the appliance
- all defects caused by incorrect electrical connection
- all defects caused by normal wear (for instance compressor failure and fluorescent lamp malfunctioning that is not due to manufacturing defects)
- calls for installation, technical instructions, adjustments and cleaning the condenser

If the seller's technical staff detect any tampering, unauthorised repairs or inappropriate use of appliance the warranty will be invalidated.

Shipment of components covered by the warranty is freight collect only.

Any damage to the appliance detected at the time of delivery due to transport must be reported on the same shipping note to claim compensation from the carrier.

The seller cannot be held liable in the event of damage to the preserved product due to appliance failure

### 3. EQUIPMENT IDENTIFICATION

- Find the label affixed on the machine to read the technical data.
- Check the machine model and the power supply voltage before you perform any operation.
- If you uncover mismatches, contact the manufacturer or the company that supplied the machine immediately.

The diagram shows a technical label with the following fields and symbols:

- 1: Four circles representing symbols of compliance.
- 2: Manufacturer's address.
- 3: Ord. Prod. / Prod. Ord. (Production Order).
- 4: Tipologia / Type.
- 5: Modello / Model.
- 6: Articolo / Article.
- 7: Matricola Nr. / Serial Number.
- 8: Data Prod. / Prod. Date.
- 9: V (Voltage).
- 10: Hz (Frequency).
- 11: Capacità lorda / Gross volume.
- 12: W (Absorption at Rated Capacity).
- 13: W (Absorption during Defrosting).
- 14: W (Absorption of Heating Elements).
- 15: W (Lamp Power).
- 16: A (Fuse Value).
- 17: Classe / Class.
- 18: Nr (Number of Motors).
- 19: Type of Coolant.
- 20: Kg (Amount of Coolant).
- 21: Classe / Class (Safety Class).
- 22-23: Ordine Cliente / Customer order.
- 24: RAEE Mark (Foaming gas: CO<sub>2</sub>).

- |         |                                    |
|---------|------------------------------------|
| 1       | Symbols of Compliance              |
| 2       | Manufacturer's address             |
| 3       | Production Order                   |
| 4       | Type                               |
| 5       | Model Name                         |
| 6       | Article                            |
| 7       | Serial Number                      |
| 8       | Production Date                    |
| 9 - 10  | Power supply Voltage and Frequency |
| 11      | Gross Capacity                     |
| 12      | Absorption at Rated Capacity       |
| 13      | Absorption during Defrosting       |
| 14      | Absorption of Heating Elements     |
| 15      | Lamp Power                         |
| 16      | Fuse Value                         |
| 17      | Climate Class                      |
| 18      | Number of Motors                   |
| 19      | Type of Coolant                    |
| 20      | Amount of Coolant                  |
| 21      | Safety Class                       |
| 22 - 23 | Customer order                     |
| 24      | RAEE Mark                          |

## 4. USE

This appliance is exclusively intended to:

### DISPLAY AND SELL SPREADABLE ICE CREAM

The manufacturer is not liable for injury to persons or damage to property or the appliance itself caused by the displaying of products other than those described above.

Never use electric devices inside this appliance.

Do not use mechanical or other means to accelerate the defrosting process, other than recommended by the manufacturer.

Keep the air vents in the casing of the appliance or in the structure built into the wall free of obstructions.



#### THE APPLIANCE IS INTENDED FOR PROFESSIONAL USE.

##### Uses not allowed

- Food preservation.
- Displaying and/or preserving non-food products (chemicals, pharmaceuticals, etc...).

### 4.1 COMPOSITION

The appliance is made up from a unique cabinet, onto which all devices necessary to make it a professional and efficient product for its declared use, are installed.

The appliance is made up from:

- Cooling system at Ventilated Refrigeration (RV) - DISPLAY
- Cooling system at Static Refrigeration (RS) - STORAGE ROOM
- Condensing unit on board (UCA)
- Electric system
- Electronic controller
- Insulated monolithic structure in ecological polyurethane
- Operator side closure with self rolling curtain
- Swivel casters with brakes
- Lighting LED



## 5. NOTES / IMPORTANT NOTES



The content of this manual is of technical nature and is owned by **ISA**. It is forbidden to reproduce, circulate or modify all or part of its content without written consent. Any infringement will be legally pursued.

The manual and the conformity certificate are an integral part of the equipment and should always accompany the product in the event of a transfer to a new location or to a new owner. The user is responsible for the integrity of these documents, for their consultation and during the whole life cycle of the equipment itself. Keep this manual in a safe place. It should be available for consultation near the equipment at all times. If lost or destroyed, you can request a copy of the manual from **ISA** by specifying the exact model, serial number and year of manufacture. The manual reflects the manufacturing technology at the time of supply. The manufacturer reserves the right to modify its products in any way it deems necessary, with no obligation to update manuals and machines relating to previous manufacturing batches.

This equipment is not intended for use by persons (including children) with reduced physical, sensory or mental capabilities or by persons lacking the necessary experience and knowledge, unless they are supervised by a person responsible for their safety who has instructed them on how to use the equipment. Children should be supervised to ensure that they do not play with the equipment. Always refer to this manual before going ahead with any operation. Before doing any type of work, disconnect the equipment from the power supply. Any work on electric and electronic parts or cooling system components should only be carried out by trained personnel in compliance with current laws.

The Manufacturer cannot be held liable for any injury to persons or animals, or damage to the product itself in the event of:

- Improper use of the equipment or use of the appliance by unqualified or unauthorised personnel
- Failure to comply with current legislation
- Incorrect installation and/or power supply faults;
- Failure to observe the instructions contained in this Manual;
- Failure to follow the maintenance programme;
- Unauthorised modifications;
- Installation of non-original spare parts in the equipment;
- Installation and use of the equipment for purposes other than those for which the appliance was designed and sold;
- Tampering with or damage to the power supply cable.

Liability for applying the safety instructions contained in this manual is held by the technical personnel responsible for the intended use of the equipment, who should ensure that authorised personnel:

- Are qualified to carry out the requested activity;
- Are aware of, and carefully comply with, the instructions contained in this document;
- Are aware of, and apply, the general safety standards applicable to the equipment

The buyer is responsible for training personnel using the appliance on the risks, safety devices and general health and safety rules required by the laws of the country where the appliance is installed. Users/operators should be aware of the position of all the controls and how they work, as well as of the features of the appliance.

They should also read this manual in its entirety.

Maintenance work should be conducted by qualified personnel after the appliance has been prepared adequately.



### **Danger**

Unauthorised tampering or replacement of one or more parts of the appliance, use of accessories that modify the use of the same and use of spare parts different to those recommended, can become the cause of injury.



### **Danger**

Any work conducted on the on the appliance **must** involve disconnection from the power socket and in any case, none of the protective elements (grid, casing) should be removed by non-qualified staff. The appliance should not be operated when these protective elements have been removed.

## STAFF TRAINING

The buyer is responsible for ensuring personnel who will use the appliance and maintenance technical staff are instructed and trained adequately.

The manufacturer is available for advice, clarifications, etc. so that the operator and technical staff can use the appliance correctly.

To ensure the operator's safety, appliance devices should be kept in constant working order. This manual is intended to illustrate the use and maintenance of the appliance. The operator has a responsibility and duty to carefully observe the instructions contained within it.

Failure to comply with safety standards may result in injury to personnel and damage to the equipment components and control unit. The user can contact the dealer to request additional information not contained in this document, or suggest improvements, at any time.



Before the product is delivered to the customer, it is essential that a **trained technical member of staff** checks that the appliance is operating correctly in order to achieve maximum performance.

## INTRODUCTION

ISA employs materials of the best quality and as they enter the company, we constantly monitor their storage and the use as part of the manufacturing process to prevent damage, deterioration and failure. All manufacturing elements are designed and manufactured in order to guarantee reliability and high safety standards. All appliances are subjected to a strict testing procedure before delivery. However, please bear in mind that product performance over time depends on correct use and adequate maintenance. This manual contains the necessary instructions to maintain the appliance's initial appearance and functions over time.



### Note

In order not to compromise functionality and safety of the appliance, the particularly complex installation and maintenance activities are not documented in this manual and are performed by specialised ISA s.r.l. technicians.

The Use and Maintenance manual contains the necessary information for understanding how the appliance works and how to use it properly, namely: the technical description of the various operational units, equipment and safety systems, operations, how to use the instruments and the interpretation of any diagnostics reports, main procedures and information relating to routine maintenance. For correct use of the appliance, the working environment should comply with current health and safety standards.

The safety requirements, indications, standards and notes illustrated in the various chapters of the manual are aimed at establishing a code of conduct and a series of obligations to be observed when performing the various activities, in order to create safe conditions for personnel, the equipment and the surrounding environment. The safety standards reported in this document are intended for trained, authorised personnel responsible for:

- Transport
- Installation
- Operation
- Management
- Maintenance
- Cleaning
- Putting out of order
- Disposal



### Attention

Reading this manual, albeit in full, is no substitute for adequate user experience. therefore it should only be considered a useful reminder of the technical features and the main operations to perform.



### Warning

The installers and users must read and understand the instructions contained herein before any operation on the appliance.



## 6. SAFETY

The appliance is equipped with safety devices.

### 6.1 SAFETY DEVICES PRESENT

Devices whose operation prevents the occurrence of risk situations in operating conditions (e.g. fuses, pressure switches, protections, magnet circuit breakers, etc.).

### 6.2 FIXED PROTECTIONS

Fixed protective devices consist of fixed perimeter shields, which are used to prevent external parts from entering the equipment.



#### **Danger**

It is prohibited to re-start the appliance following maintenance without having correctly restores the panels.



#### **Visual Check**

You should check the integrity of fixed panels and corresponding fixings to the frame, focussing in particular on the protective panels.

### 6.3 ISOLATING THE ELECTRIC POWER SUPPLY

Before conducting any maintenance work on the equipment or part of it, it is necessary to section the power supply that powers it.



#### **Danger**

In the event of maintenance operations in which the operator cannot prevent accidental closure of the circuit by others, to totally disconnect the appliance from the mains electricity.

### 6.4 RESIDUAL RISKS

During design the manufacturer examined all the areas or parts at risk. Therefore, all necessary precautions have been taken to prevent risks to persons and damage to the appliance.



#### **Attention**

Periodically check that all safety devices are operating correctly.  
Do not remove the fixed guards.  
Do not introduce objects or tools into the work area.

Although the appliance is fitted with the safety devices prepared, there are still some risks that cannot be eliminated, but reduced via corrective actions by the final integrator and correct operational procedures.

### 6.5 RISKS OF CONTACT WITH LIVE PARTS

Risk of breaking or damaging the electrical components of the appliance, with a possible reduction in safety levels, following a short circuit.

Before connecting the electricity supply, make sure there is no ongoing maintenance work.



#### **Attention**

Before making the connection, check that the d.c. current in the installation point does not exceed that indicated on the protections switches present in the electric control board. If this is not the case, the user must envision the relevant limiting devices.  
It is strictly forbidden to conduct any electrical modification, in order to prevent additional unforeseen hazards and risks.

## 6.6 FIRE



### **Danger**

In the event of a fire, immediately disconnect the master switch from the main power supply line.

## 6.7 EXPLOSIVE ATMOSPHERE

The equipment must not be located in an area classified as an explosion risk according to 1999/92/EC such as:

### **Zone 0**

An area in which there is a permanent, long-lasting or frequently explosive atmosphere made up of a mixture of air and flammable substances in the form of gases, fumes or steam.

### **Zone 1**

An area in which the formation of an explosive atmosphere, made up of a mixture of air and flammable substances in the form of gases, fumes or steam is occasionally probable during normal activities.

### **Zone 20**

An area in which there is a permanent, long-lasting or frequently explosive atmosphere in the form of clouds of combustible dust in the air.

### **Zone 21**

An area in which the formation of an explosive atmosphere in the form of clouds of combustible dust is occasionally probable during normal activities.

## 6.8 SLIPPING



Any leaks in the areas surrounding the appliance may cause personnel to slip. Check that there are no leaks and keep these areas clean at all times.

## 6.9 TRIPPING



Generally untidy deposits of material may constitute a tripping hazard and a total or partial obstruction of emergency exit routes.

Ensure that operating and transit areas and emergency exit routes are free from obstacles in compliance with current legislation.

## 6.10 CIRCUIT FAULTS

Owing to potential faults, safety circuits may become less effective, which results in lower safety levels. You should check the operational condition of the appliance devices regularly.

## 6.11 WARNING SIGNS (if any)

The appliance is fitted with warning danger, warning and obligation signs defined in agreement with the Standard relative to the graphical signs to be used on plants.

The signs are located in clearly visible positions.



### **Attention**

The warning plates present on the appliance must not be removed.

The user is responsible for replacing warning signs that, owing to wear, become unreadable.

## 6.12 RISKS OF EXPLOSION

Do not store products that contain combustible gaseous propellants and explosive substances inside the appliance.

## 6.13 FALLING OBJECTS

Positioning of the cabinet display parts (i.e. counters, rods and hooks), as also product arrangement inside the cabinet can be the source of potential hazards if not properly performed.

Follow the positioning instructions described in this Manual before you place products inside the cabinet, check that the counters are properly fastened, as also the hooks, etc. Do not exceed the maximum load limit. Do not tilt the shelves. Do not place any goods and in general, do not load the tank sliding element closing devices with any load, while open or closed.

Do not place any goods and in general, do not load the tank sliding element closing devices with any load, while open or closed.

## 6.14 COOLING











During different operations to perform on the counter, such as cleaning or loading goods, it is necessary to handle products and/or counter parts at a low temperature with the risk of “cold injury” for the operators and/or accidental slipping hazard.

Follow the safety regulations in the place where the cabinet is installed; more specifically, be sure to always use the right PPE (especially gloves).

## 6.15 FOODSTUFFS SAFETY (PACKAGED PRODUCTS)

The refrigerator cabinet described herein is meant to be used to display packaged products. As such, it is not designed for direct contact between the foodstuffs and display surfaces. If the foodstuffs do accidentally make contact with the surfaces and for a rather long time, the product may be contaminated. Follow the guidelines on how to use the cabinet. If a product package breaks, remove it from the cabinet and clean, if necessary.

## 6.16 REFRIGERANTS (where applicable)

REFRIGERANT	DESCRIPTION
	 <p>The refrigerant <b>R290</b> is a gas that is compatible with the environment, but <b>highly flammable</b>. Pay close attention during transport, installation and that the destruction not to damage the refrigerant pipelines.</p> <p><b>IN THE EVENT OF DAMAGE:</b> Keep flames or sources of ignition away from the appliance. Properly ventilate the premises for a few minutes. Turn the unit off, pull the plug. Inform customer support service. The more refrigerant containing an appliance, the greater must be the environment in which there is the unit. In areas too small, in the event of leakage can form a flammable mixture of air and gas. <b>The volume of the room where the appliance is installed must be at least 19 m<sup>3</sup> for each cooling system present in the room.</b></p> <p><b>WARNING</b>  Maintenance must be performed by qualified personnel that has been to work with flammable refrigerants.</p>
	 <p>The refrigerant <b>R600a</b> is a gas that is compatible with the environment, but <b>highly flammable</b>. Pay close attention during transport, installation and that the destruction not to damage the refrigerant pipelines.</p> <p><b>IN THE EVENT OF DAMAGE:</b> Keep flames or sources of ignition away from the appliance. Properly ventilate the premises for a few minutes. Turn the unit off, pull the plug. Inform customer support service. The more refrigerant containing an appliance, the greater must be the environment in which there is the unit. In areas too small, in the event of leakage can form a flammable mixture of air and gas. <b>The volume of the room where the appliance is installed must be at least 17 m<sup>3</sup> for each cooling system present in the room.</b></p> <p><b>WARNING</b>  Maintenance must be performed by qualified personnel that has been to work with flammable refrigerants.</p>
	<p>The refrigerant <b>R744</b> is a gas that is compatible with the environment. Pay close attention during transport, installation and that the destruction not to damage the refrigerant pipelines.</p> <p><b>IN THE EVENT OF DAMAGE:</b> Keep away from the flame or ignition sources. Properly ventilate the premises for a few minutes. Turn the unit off, pull the plug. Inform customer support service.</p> <div data-bbox="432 1554 1331 1720" style="border: 1px solid black; padding: 5px;"> <p><b>WARNING</b> The refrigerant system is <b>High Pressure</b>. Do not tamper with the system, but call a specialised and qualified technician before disassembly. Maintenance must be performed exclusively by qualified staff.</p> <div style="text-align: center;">  <p><b>HIGH PRESSURE</b></p> </div> </div> <p> </p>

## 7. DISPOSAL OF WASTE MATERIAL

During normal operation, the appliance does not generate any environmental contamination. At the end of its life cycle, or if it is necessary to proceed to permanent decommissioning, we recommend following the procedures below:

### DISPOSAL (User)



The symbol, applied to either the product or its packaging, indicates that the product should not be considered as normal domestic waste, but should be taken to a waste collection point for the recycling of electrical and electronic appliances. The correct disposal of this product helps to prevent potential negative consequences that might derive from inadequate product disposal. For detailed information about recycling this product, contact your council, your local waste collection service or the store where you purchased the product.

### PROCEDURE FOR DISPOSAL and RECYCLING AT THE END OF APPLIANCE LIFE SPAN (Authorised bodies)

- Switch off the equipment and unplug the power supply cable.
- Remove the lamps (if installed). These should be disposed of separately.
- Remove the power units and the electronic cards. These should be disposed of separately.
- Remove all the independent parts (grids, casings, profiles, etc.) and group them according to shared features in order to access the heat exchangers, pipes, cables, etc. and be careful not to damage the cooling circuit.
- Remove all mobile parts (doors, sliding doors, glass parts, etc.) and group the various materials according to their features.
- Check the type of refrigerant on the plate positioned inside the counter; extract the refrigerant and dispose of it through authorised services.
- Disconnect the evaporator, the condenser, the compressor, the pipes and fans. These are made of copper, aluminium, steel and plastic and should therefore be disposed of separately.
- On removal of all guards and the various components from the frame, separate the different types of material making up the appliance (plastic, sheet steel, polyurethane, copper, etc) and collect them separately.



All recyclable materials and waste should be processed and recycled by professionals, in compliance with the laws in the country in question. The company responsible for recycling the materials should be registered and certified as a waste disposal service in accordance with the country in question.



#### Attention

Illegal disposal of the product by the owner will result in administrative sanctions as required by current laws. Disposal of the product should comply with current laws on the disposal of coolant liquids and mineral oils.



#### Important

If the crossed wheeled bin sign is not present on the appliance, it means that the disposal of the product is not the manufacturer's responsibility. In this case, the Regulations regarding the disposal of waste in force are valid.



#### Additional information

Further information on the disposal of liquid coolant, oils and other substances is available on the safety data sheet corresponding to the substance itself.

In order to dispose of foamed assemblies, remember that the polyurethane foams used are CFC, HFC and HCFC free.

## 8. INSTALLATION

This manual supplies the information necessary for correct unpacking, procedures for positioning and connection to mains electricity.

### 8.1 STORAGE AND UNPACKING

The appliance, with or without the packaging, should be carefully stored inside warehouses or in areas away from the elements and direct sunlight, at a temperature between **0** and **+40** °C.



The appliance should only be moved by qualified personnel operating forklift trucks, the power of which should be suited to handling the weight of the product.

During said operation the appliance **MUST** be placed on the special pallet supplied.



Unpack the appliance by removing the screws fixing it to the pallet.  
All packaging materials are recyclable and should be disposed of in accordance with local regulations.  
Please destroy "plastic" bags to prevent them from becoming hazardous to children (suffocation).

### 8.2 INSTALLATION - POSITIONING - ENVIRONMENTAL CONDITIONS



#### Attention

A dry room that can be ventilated is the suitable location for the appliance's installation. There should be a good air flow around the compressor/condensing unit. Therefore the area around the unit should not be obstructed by boxes or other objects. Position the appliance away from heat sources (radiators, stoves of all types, etc.) and away from the effects of continuous currents of air (e.g. caused by fans, air conditioning vents, etc.). If it is unavoidable to install near a heat source, use a suitable insulating plate, Also avoid exposure to direct sunlight; all of this causes the temperature inside the refrigerated compartment to rise with negative consequences on operation and energy consumption. Do not use the appliance outdoors and do not leave it exposed to rain.

### 8.3 ELECTRIC CONNECTION



#### Attention

Check that the network voltage matches the one displayed on the identification plate of the appliance, and that the power is adequate.  
Check on the socket that the power supply voltage provides rated voltage ( $\pm 10\%$ ) when you start up the compressor.  
The plug should be directly connected to the electrical socket.  
It is forbidden to connect the plug to the socket by means of multiple socket extensions or adaptors.  
The plant power supply socket must be fitted with a disconnection device from the mains electricity (dimensioned to the load and in compliance with Standards in force), which guarantees complete disconnection in category III (3) over-voltage conditions and therefore protects the circuits against earth faults, overloads and short circuits.  
Do not route the electricity cable in passageways.





#### Attention

Earthing is necessary and mandatory by law.



## 9. MAINTENANCE

The **Staff in charge of the appliance** must control and respect the expiry dates for maintenance, given in the table below, calling the authorised **Technical After-sales assistance** when indicated.

OPERATION	FREQUENCY				ORDINARY	EXTRAORDINARY	AUTHORISED PERSONNEL
	Depending on the Use and Necessity	Monthly	six-month	Annual			
CLEANING THE EXTERNAL SURFACES	X				X		USER
CLEANING THE ACCESSIBLE INTERNAL PARTS (without the use of tools)	X				X		
CONTROL POWER SUPPLY CABLE, PLUGS AND / OR ELECTRICAL SOCKETS			X		X		
INTEGRITY CONTROL SEAL		X			X		
FILTER CLEANING CONDENSING UNIT (whenever present)			X		X		
CLEANING THE DEFROSTING WATER COLLECTION TRAY	X				X		 TECHNICAL ASSISTANCE SERVICE
CONDENSER CLEANING	X			X	X		
CHECK COMPRESSORE OIL LEVEL (whenever present)			X		X		
AIR TANK DRAINING (whenever present)			X		X		
CONTROL PNEUMATIC CONNECTIONS (whenever present)			X		X		
INTEGRITY CONTROL PIPE COOLING SYSTEM			X		X		
INSPECTION OF CABLES INTERNAL CONNECTIONS AND POWER			X		X		
CLEANING CONDENSATE DRYING SPONGES (whenever present)			X		X		
LAMP / LED REPLACEMENT (whenever present)						X	
CONTROL PANEL REPLACING (electronic control unit - thermostat - etc)						X	
REPLACEMENT POWER SUPPLY CABLE, PLUGS AND / OR ELECTRICAL SOCKETS						X	
<b>Attention</b>  After all maintenance it is <b>mandatory</b> to perform all electric safety tests in agreement with the IEC EN 50106 Standard.							

## 10. FAULTS - TECHNICAL AFTER-SALES ASSISTANCE

If the appliance is not working properly or stops working, **before contacting the Customer support centre**, check the following:

THE APPLIANCE IS NOT WORKING		
CAUSE	SOLUTION	AUTHORISED PERSONNEL
Blown protective fuse	Previously find the cause of the intervention of the switch, and then re-introduce the new fuse.	USER
The master switch is open	Close the master switch.	
The plug is not inserted	Insert the plug.	
Electric black-out	If the black-out should be prolonged, transfer the product into an appropriate cold storage container.	
THE INTERNAL TEMPERATURE IS NOT LOW ENOUGH		
CAUSE	SOLUTION	AUTHORISED PERSONNEL
Evaporator/s obstructed completely by ice	Carry out an additional defrosting cycle.	USER
Wrong setting temperature	Set the appropriate temperature.	
The appliance is affected by draughts or is exposed to direct or reflected sunlight	Remove any draughts and prevent any direct or reflected sunlight.	
Insufficient cooling air flow rate of the air condenser	Remove anything that may affect air flow inside the condensing unit (paper sheets, cardboard, grids with an insufficient number of holes, etc.).	
Internal fans at standstill or with fans damage		TECHNICAL ASSISTANCE 
Internal ventilation is too high		
Thermostat / Electronic control unit is not efficient	Replace the electronic control board. If the control unit is set up especially for must <b>R290</b> refrigerant, it must only be replaced with an original replacement from ISA. Replace the temperature probes only after checking which of the two is not operating efficiently.	
Air condenser blocked by dust or dirt in general	Clean the condensing unit thoroughly. The air condenser or MAINTENANCE FREE, in particular heavy environments (eg presence of dust, the presence of excessive moisture, oiled vapours etc..) in order to avoid performance loss, needs accurate cleaning.	
Insufficient refrigerant load in the cooling system	TFind the cause behind the lower amounts of coolant and eliminate it. Top up the coolant. If necessary, empty the system before topping up.	
THE COMPRESSOR DOES NOT START-UP OR OPERATES		
CAUSE	SOLUTION	AUTHORISED PERSONNEL
No electric power supply to the appliance	Check if there is a power cut. Close the various switches on the power supply line.	USER
The power supply voltage is too low	Check that the network voltage of the power supply cable is 220V +/- 10%.	
Temperature set too high	If the set temperature is higher than that of the air in the display area, the compressor does not activate itself. Set a more suitable temperature if the current value is not low enough	
The pressure switch (if any) was activated at maximum pressure	Check the reasons why the pressure switch is operating at maximum pressure levels, such as: air condensing unit blocked, condensing unit fan stopped, ambient temperature too high, pressure switch broken.	TECHNICAL ASSISTANCE 

## 10.1 ALARMS LIST (where present)

ALARM	DESCRIPTION	OUTPUTS	AUTHORISED PERSONNEL
			
<b>P1</b> <b>E0</b>	Broken thermostat probe. Compressor output according to “CO <sub>n</sub> ” and “CO <sub>F</sub> ” parameters	<ul style="list-style-type: none"> <li>The alarm starts a few seconds after the probe breaks down; it stops a few seconds after the probe starts working again properly.</li> <li>We recommend checking the probe connections before replacing it.</li> </ul>	
<b>P2</b> <b>E1</b>	Broken evaporator probe. Set time for defrosting.	<ul style="list-style-type: none"> <li>The alarm starts a few seconds after the probe breaks down; it stops a few seconds after the probe starts working again properly.</li> <li>We recommend checking the probe connections before replacing it.</li> </ul>	
<b>HA</b> <b>HI</b>	High temperature alarm.	<ul style="list-style-type: none"> <li>The alarm stops automatically on reaching the temperature set.</li> <li>Check programming.</li> </ul>	
<b>LA</b> <b>LO</b>	Low temperature alarm.	<ul style="list-style-type: none"> <li>The alarm stops automatically on reaching the temperature set.</li> <li>Check programming.</li> </ul>	
<b>EA</b> <b>IA</b> <b>CB</b>	External alarm.	<ul style="list-style-type: none"> <li>The external alarm stops after the digital infeed is deactivated, it is restored automatically.</li> <li>The alarm is linked to the intervention of the pressure switch and/or the compressor circuit breaker, when present.</li> </ul>	
<b>ETc</b> <b>RTF</b>	Real time clock is broken.	<ul style="list-style-type: none"> <li>Reset the clock.</li> <li>If the alarm does not stop, replace the clock.</li> </ul>	
<b>EE</b>	Machine parameter error.	<ul style="list-style-type: none"> <li>The instrument is damaged. It must be replaced.</li> </ul>	
<b>EF</b>	Operating parameters error.	<ul style="list-style-type: none"> <li>The instrument is damaged. It must be replaced.</li> </ul>	

## 11. TECHNICAL SPECIFICATIONS

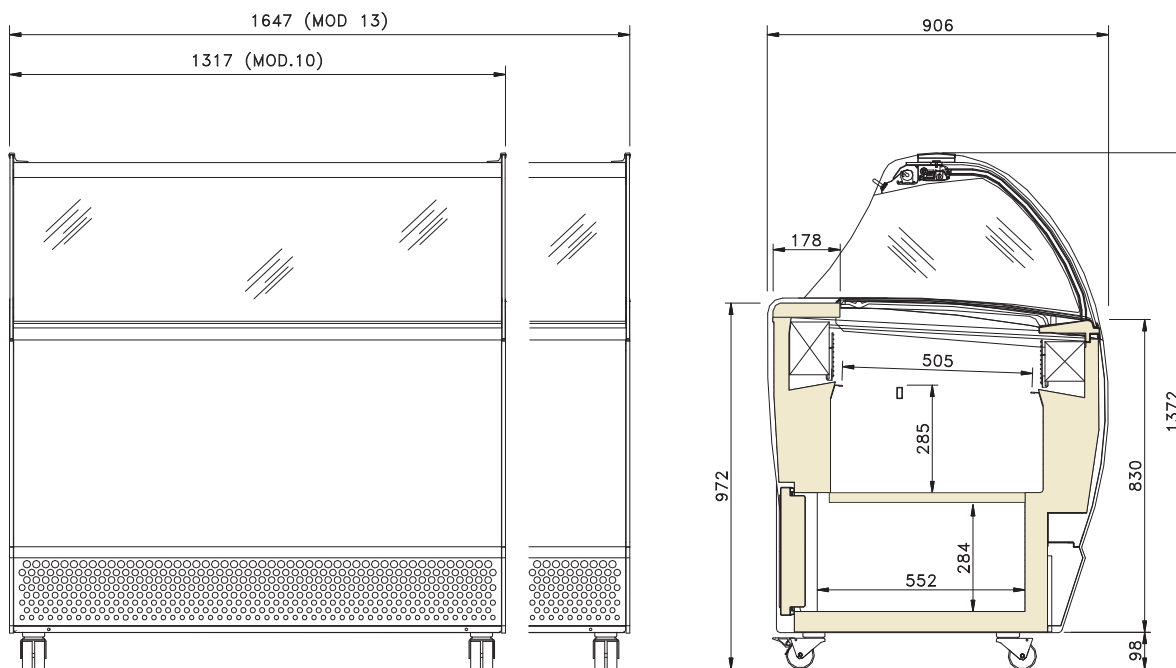

			10	13
			RS TB	RS TB
External dimensions	Length	mm	1317	1647
	Depth	mm	906	
	Height	mm	1372	
Refrigeration	DISPLAY		Static	
	STORAGE ROOM		Static	
Defrosting	DISPLAY		Hot Gas	
	STORAGE ROOM		Manual	
Climate class	N°	4		
Environmental conditions	°C / %RH	30 / 55		
Product class	°C	-16/-14		
Safety class (IEC EN 60335-2-89)	N° / °C	5 / 43 ± 2°C		
Refrigerant		R290		
Power supply	V / ph / Hz	230 / 1 / 50		
Electrical input	Standard	W / A	590 / 3	980 / 5.1
	Defrosting	W / A	1110 / 5.2	1240 / 5.8
Weight (net)	Kg	132	192	

## 11.1 CONTAINERS ARRANGEMENT ICE CREAM CONTAINERS

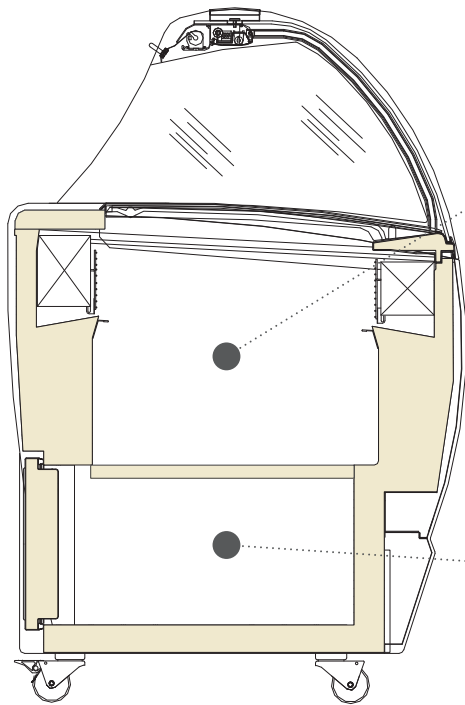

### VASCA ESPOSITIVA

<b>10</b>	<b>13</b>
-----------	-----------

lt 5  
(360x165x120H)



10 (+10)

13 (+13)

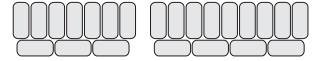

lt 4.75  
(260x157x170H)



14

18

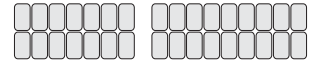

### CELLA DI RISERVA

<b>10</b>	<b>13</b>
-----------	-----------

lt 5  
(360x165x120H)



5 (+5)

7 (+7)



lt 4.75  
(260x157x170H)



8

10



## 11.2 INSTALLATION



### Attention

It is fundamental to respect the distances indicated (mm) for correct installation of the appliance.

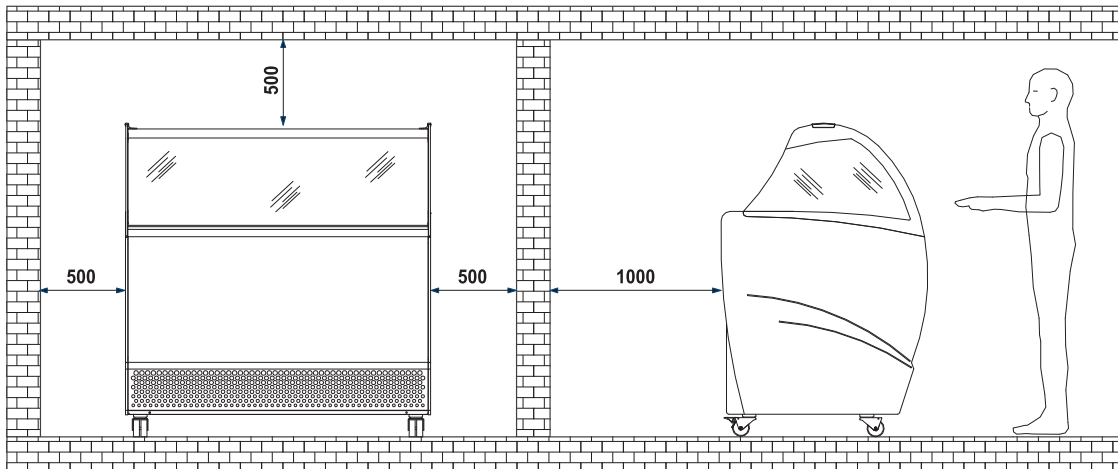

## 11.3 LOAD LIMITS



### Attention

It is fundamental **not to exceed** the load limits indicated in order not to alter the correct air circulation and thus prevent a high product temperature.



The limits given refer to a static load and evenly distributed. Are therefore excluded dynamic overloads due to loading operations violent, ranging absolutely avoided for safety reasons.

## 11.4 LIGHTING (LED)

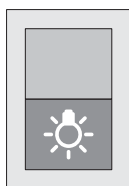
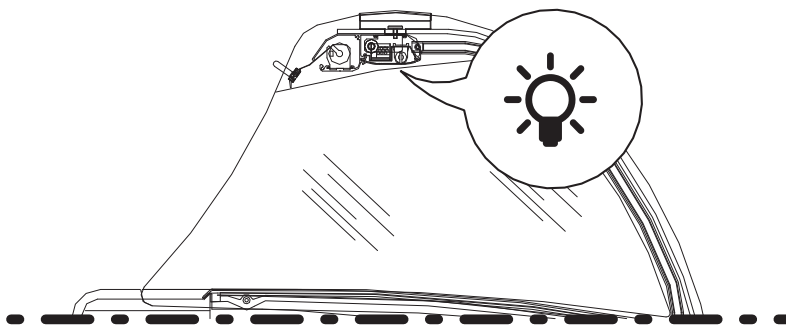

**PUSH**



## 11.5 POSITIONING



### Warning

#### SWIVEL CASTERS

The equipment is set up with four (4) swivel casters (2 with brakes) for easy handling and positioning.

It is **absolutely necessary** after placement stabilize the equipment on the floor.

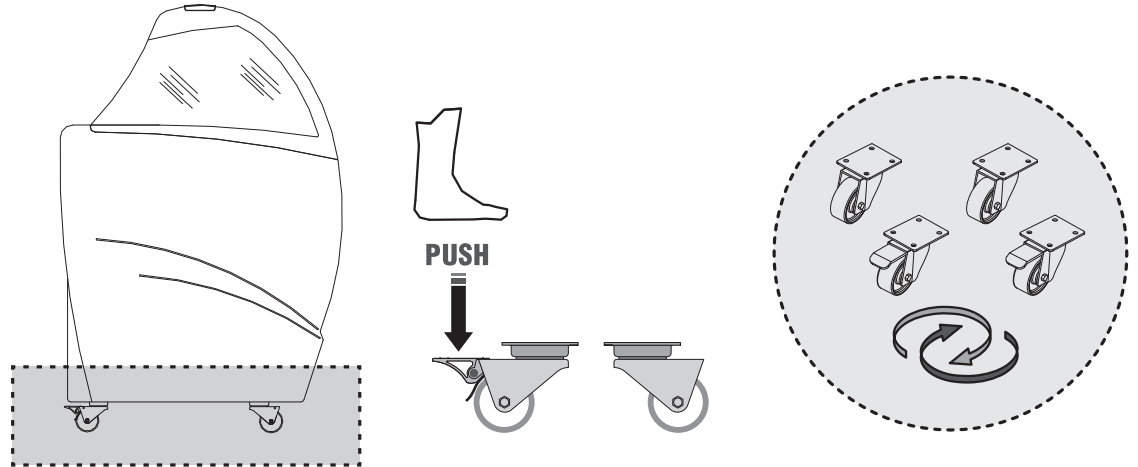

## 11.6 OPEN / CLOSE SELF ROLLING CURTAIN

Open / close the self rolling curtain as shown in figure.



### Attention

Scroll through the self rolling curtain without force and ensure complete / correct closure; not the complete / correct closure will cause the negatively affects performance of the equipment and on the excessive ice buildup on the inner walls.

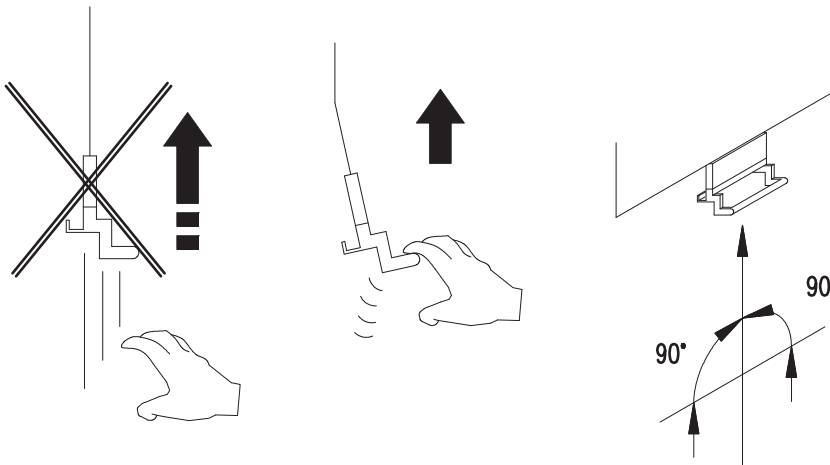
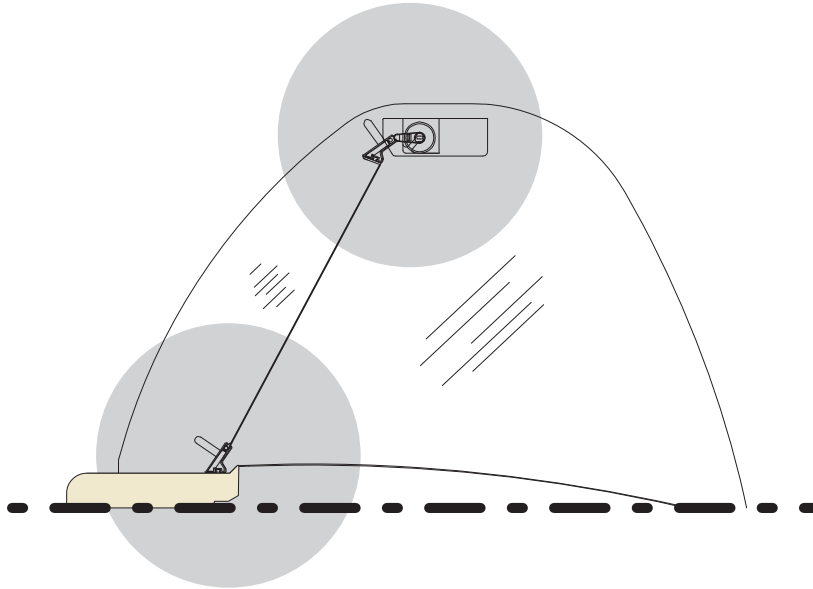

## 12. CONTROL PANEL

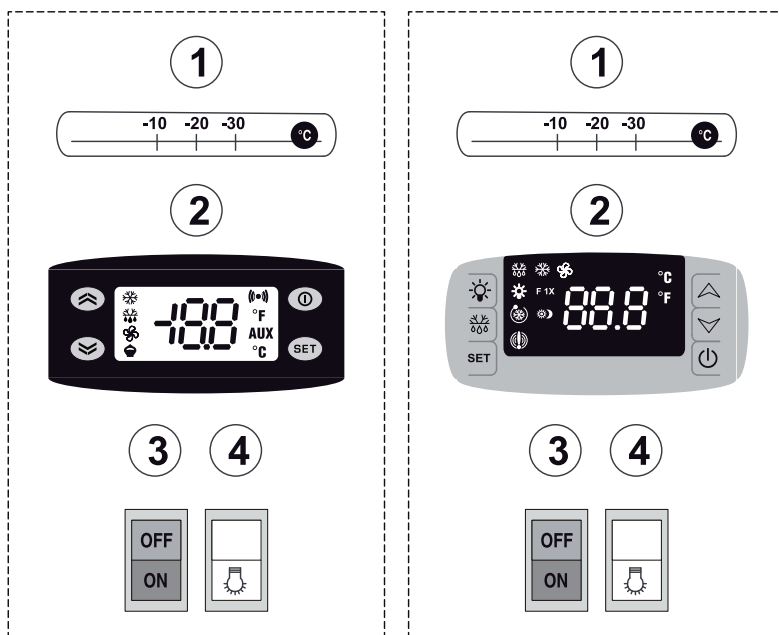
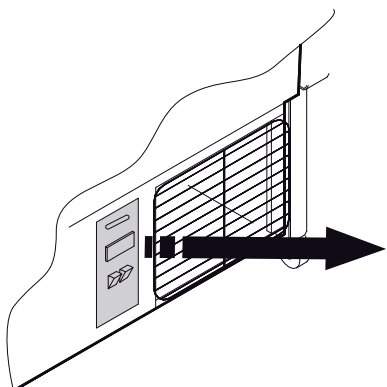

1	THERMOMETER (STORAGE ROOM)
2	ELECTRONIC CONTROL BOARD
3	CABINET SWITCH
4	LIGHTING SWITCH

### START-UP

Press the master switch network.

Plug the appliance in at the socket supplied by the customer, ensuring that the plug is fitted with an earth contact and that there are no multiple sockets connected to it; the equipment automatically starts.

The equipment starts automatically otherwise press "3".

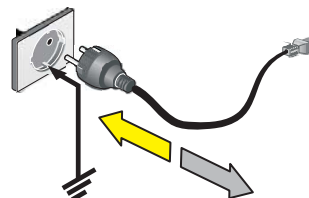

#### Attention

The electronic control board is installed already programmed. Any changes to the control board settings can be carried out exclusively by qualified technical personnel.

At start-up, the instrument conducts a **LAMP TEST** for a few seconds. The display and leds flash to verify their integrity and to ensure they are working correctly.

## 12.1 USER INTERFACE - EW978







KEYS	
	<p><b>UP</b>            Scrolls menu options.            Increases the values.            Activates manual defrosting.</p> <p><b>MANUAL ACTIVATION OF THE DEFROSTING CYCLE</b>            To manually activate the defrosting cycle, press and hold the <b>UP</b> key for 5 seconds. If defrosting conditions are not present (for instance the temperature of the evaporator probe is higher than the temperature at the end of the defrosting process), the display will flash three (3) times to indicate that the operation will not be performed.</p>
	<p><b>DOWN</b>            Scrolls menu options.            Decreases the values.</p>
	<p><b>STAND-BY (ESC)</b>            Goes back up one level with respect to current menu.            Confirms parameter value.            Activates the Stand-by function.            ON / OFF the equipment.</p>
	<p><b>SET (ENTER)</b>            Accesses the Set-point.            Accesses the programming menu.            Confirm the commands.</p>

SETTING THE SET POINT	
	<p>Press the <b>SET (ENTER)</b> button and release immediately.            The "Set" label will appear.            To view the Set point value, press the <b>SET (ENTER)</b> button again.            The Set-point value will appear on the display.</p>
	<p>To change the Set point value, press the <b>UP</b> and <b>DOWN</b> buttons within 15 seconds.</p>
	<p>To confirm the new Set-point value set, press the <b>SET (ENTER)</b> key again.</p>
	<p>By not operating on the keyboard for more than 15 seconds (time-out) or pressing the <b>STAND-BY (ESC)</b> key once, the last value displayed is confirmed and you go back to the previous display.</p>

## 12.1 USER INTERFACE - EW978



LED	
	<p><b>COMPRESSOR or RELAY 1</b> ON for compressor on. Flashing for delay, protection or blocked activation.</p>
	<p><b>DEFROSTING</b> ON for defrosting in progress. Flashing for manual activation.</p>
	<p><b>ALARM</b> ON for active alarm. Flashing for silenced alarm. Alarm conditions are always signalled by the buzzer (if present) and by the corresponding alarm icon LED. The alarm signal deriving from a faulty probe (probe 1) appears directly on the instrument display with the indication E1. The alarm signal deriving from a faulty evaporator probe (probe 2) appears directly on the instrument display with the indication E2.</p>
	<p><b>FANS</b> ON for operating fans.</p>

## 12.2 USER INTERFACE - XR44CX

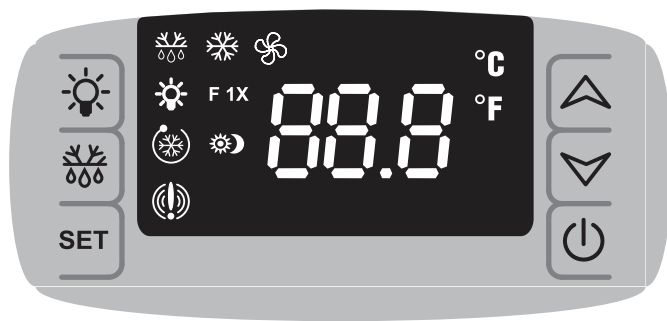

### Attention

The electronic control board is installed already programmed. Any changes to the control board settings can be carried out exclusively by qualified technical personnel.

KEYS - SINGLE PRESS	
	Not applicable.
	<b>SBR</b> To start a <b>manual defrosting cycle</b> , press for at least 2 seconds.
<b>SET</b>	To display or modify the set-point. Press and release the key to display the temperature. To go back to viewing the temperature set, wait 5 seconds or press the key again In programming mode, selects a parameter or confirms a value.
	<b>UP</b> In programming mode, scrolls the codes of the parameters or increases its value. Activates the Continuous Cycle function when present.  <b>MAXIMUM TEMPERATURE DISPLAY</b> Press and release the key (the "Hi" message will be displayed followed by the maximum temperature reached). Press the key or wait 5 seconds to go back to displaying normal temperature.
	<b>DOWN</b> In programming mode, scrolls the codes of the parameters or decreases its value. Activates the High and Low Humidity function when present.  <b>MINIMUM TEMPERATURE DISPLAY</b> Press and release the key (the "Lo" message will be displayed followed by the minimum temperature reached). Press the key or wait 5 seconds to go back to displaying normal temperature.
	Switches the instrument on or off.  Pressed for at least 2 seconds, it displays "OFF" In this configuration the loads and all adjustments are disabled; to take the instrument back to <b>ON</b> press again for at least 2 seconds.





## 12.2 USER INTERFACE - XR44CX



### Attention

The electronic control board is installed already programmed. Any changes to the control board settings can be carried out exclusively by qualified technical personnel.

### KEYS - COMBINED PRESSING

 + 	<p>To block and release the keyboard.</p> <p><b>LOCK KEYBOARD</b> Hold both keys down for a few seconds until flashing “POF” appears. The keyboard is blocked. Only the set-point of the maximum and minimum temperature can be displayed. “POF” appears if a key is pressed for more than 3 seconds.</p> <p><b>UNLOCK KEYBOARD</b> Hold both keys down for a few seconds until flashing “POn” appears.</p>
<p>SET + </p>	<p>To enter programming mode.</p>
<p>SET + </p>	<p>To exit programming mode.</p>

## 12.2 USER INTERFACE - XR44CX

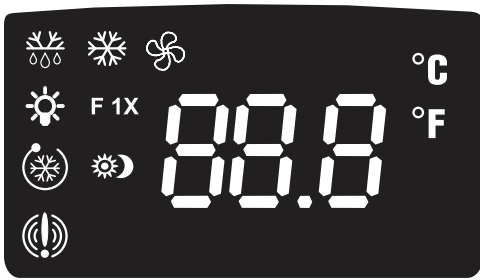

### Attention

The electronic control board is installed already programmed. Any changes to the control board settings can be carried out exclusively by qualified technical personnel.

LED	MODE	MEANING
	On	Compressor/s active
	Flashing	Delay with close start-ups
	On	Defrosting in progress
	Flashing	Dripping in progress
	On	If the temperature alarm has occurred
	On	Continuous cycle in progress
	On	Energy saving in progress
°C / °F	On	Unit of measurement
	Flashing	Programming
	On	Fan/s ON
	Flashing	Fan/s OFF

## 13. CLEANING

EXTERNAL	
<b>STAINLESS STEEL</b>	Only use warm water and non-aggressive detergents and then rinse and dry using a soft cloth.
<b>ACRYLIC OR POLYCARBONATE</b>	Wash with lukewarm water, using a soft cloth or a chamois cloth. Do not use detergents, alcohol, acetone or solvents. Do not use abrasive cloths or sponges.
<b>GLASS</b>	Only use products specifically designed for cleaning glass. We do not recommend using tap water, which may leave calcium deposits on the surface of the glass.

INTERNAL
 <p><b>Attention</b> Do not scrape the ice from the walls with pointed tools, the surfaces will be ruined. Do not use high pressure appliances (e.g. steam generators).</p> <ol style="list-style-type: none"> <li>1. Remove the product contained in the refrigerated compartment and place it immediately in a special refrigerator conservative to ensure proper storage.</li> <li>2. Turn off the equipment.</li> <li>3. Remove accessories manually removable (eg. Sliding, grills, ice cream containers, etc).</li> <li>4. Wait at least 4 to 6 hours for the possible presence of ice on the evaporator is fully dissolved before proceeding with cleaning of 'equipment. We suggest in this regard, you wait for the next day to make sure that the defrosting is completely done. Do not use mechanical devices or other means to accelerate the defrosting process, other than those recommended by the manufacturer.</li> <li>5. Remove (if present) the drain plug of the tank bottom to drain the defrost water.</li> <li>6. Clean the side panels and the bottom of the tank using a mild detergent, warm water and a cloth or sponge. Do not use sharp tools. Rinse thoroughly and dry with an absorbent cloth.</li> <li>7. If the equipment was joined to a floor drain, slide lukewarm water containing a sanitizing solution suited to the specific application. The amount of solution to be used should be such as to ensure a perfect removal of any residual product and proper sanitation along the entire path of the drainage.</li> <li>8. If the equipment is not joined to a floor drain, follow the procedure referred to above. The rinse water collected in the tank will be positioned inside the base of the apparatus. Proceed also to cleaning and sanitizing of the drip tray.</li> <li>9. Fit the accessories that were removed (step 3).</li> <li>10. Turn on the equipment and allow to cool on the bench for at least 2 hours or until it reaches the desired temperature before reintroducing foods.</li> </ol>

## 13. CLEANING

### CONDENSING UNIT

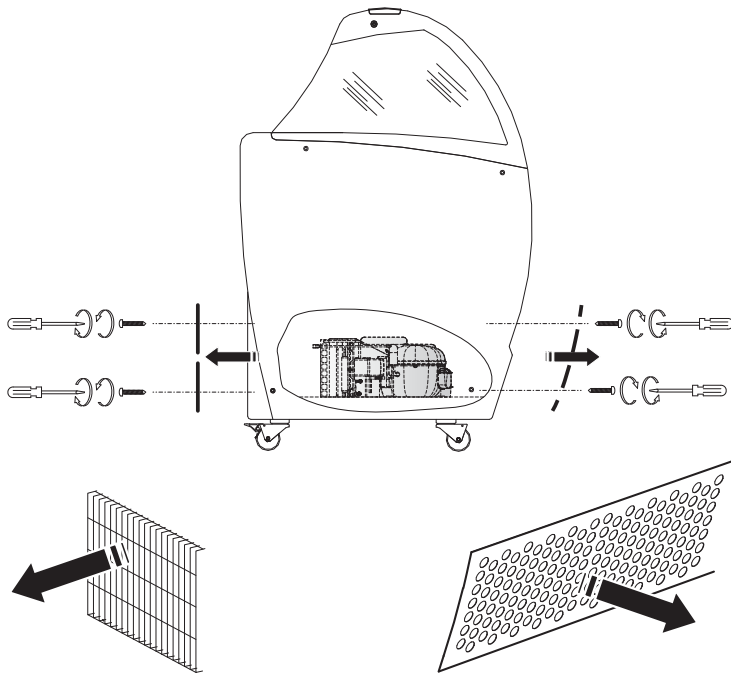

#### Attention



Turn off the product, wait a few hours until the equipment of the condensing unit has reached a temperature close to that of the environment.

Remove the screws fixing the protection grid (front and rear) and remove them as shown.

Clean the condensing unit using a suction brush. Clean the **condenser** with a soft bristle brush; make sure you do not bend the condensing unit springs whilst cleaning it.

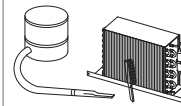

### DEFROST WATER COLLECTION TRAY (if present)

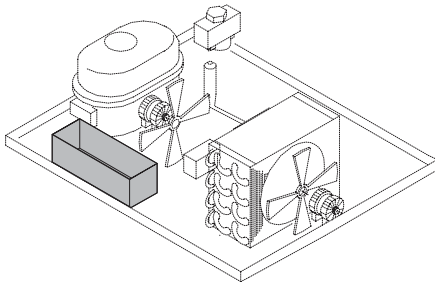

#### Attention



Clean based on use and as needed and in certain environmental conditions (e.g., high humidity, low environmental temperature, presence of dust, etc.) in order to avoid the incorrect and complete evaporation of the water and/or the presence of unpleasant odours.

Sanitize the tray with specific products.

## 14. PROLONGED APPLIANCE SWITCH-OFF

- Remove the product contained in the cabinet and put it immediately in a relevant cold storage container in order to guarantee correct preservation.
- Open the equipment and wait for it to reach room temperature and then clean it.
- Leave the door/sliding panels open by 2-3 cm so as to guarantee circulation of the air and prevent the formation of mould and bad smells inside the appliance.
- The appliance, with or without the packaging, should be carefully stored inside warehouses or in areas away from the elements and direct sunlight, at a temperature between **0** and **+ 40** °C.

## Attachment 1 - DECLARATION OF CONFORMITY

### DECLARATION OF CONFORMITY

We: **ISA S.r.l.**  
Via del Lavoro, 5 - 06083 - Bastia Umbra (PG)

declare under our own responsibility, that the product:

Product: **ISABELLA LX**

Serial number: .....

To which this declaration refers, is in compliance with e following:

#### MACHINERY SAFETY

General electric safety Standard EN 60335-1: 2012-01+ Modification A11. Particular requirements for commercial refrigerating appliances EN 60335-2-89/Ed.2010. Standard for Measuring Electromagnetic Fields (EMF) of Electrical Appliances EN 62233:2008, Directive 2006/95/EC of the European Parliament and the Council of 12th December 2006 on the harmonisation of the Laws of Member States relating to electrical equipment for use within certain voltage limits EN 62471/Ed.2009 Photo-biologic safety of lamps and lamp systems

#### ELECTROMAGNETIC COMPATIBILITY (EMC)

On the basis of the construction evaluations and test results the equipment under test is in compliance with the following standards CEI EN 55014-1 (CEI 110-1) "Electromagnetic compatibility - Requirements for household appliances, electric tools and similar apparatus" . Part 1: Emission "Fifth Edition Technical File 9159 (January 2008) with amendment A1 Technical File 10790 (October 2010) and amendment A2 Technical File 11786 (February 2012) and CEI EN 55014-2 (CEI 210-47) "Electromagnetic compatibility - Requirements for household appliances, electric tools and similar apparatus. Part 2: Immunity - Product family standard" First Edition Technical File 4788 - (October 1998) with amendments A1 Technical File 6577 (August 2002) and amendment A2 Technical File 9942 (August 2009), CEI EN 61000-3-2 (CEI 110-31) "Electromagnetic Compatibility (EMC) - Part 3-2: Limits for harmonic current emissions (equipment input current  $\leq 16A$  per phase)." Technical File 8802 (April 2007) IV Edition with amendment A1/A2 Technical File 11514 (September 2011) and CEI EN 61000-3-3 (CEI 210-96) "Electromagnetic Compatibility (EMC) - Part 3: Limits Section 3: Limitation of voltage fluctuations and flicker in low-voltage supply systems for equipment with rated current  $\leq 16A$ ." II Edition Technical File 13414 (March 2014).

#### PRESSURE EQUIPMENT DIRECTIVE (PED) 97/ 23/ EC

As the equipment falls into a class lower than I, it is excluded from the PED's application field (art.1 par.3.6)

#### FOODSTUFF COMPATIBILITY

Regulation (CE) N.1935/2004 of the European Parliament and of the Council dated 27 October 2004 Regulation (CE) N.2023/2006 of the Council dated 22 December, Directive 2008/39/CE of the Council dated 6 March 2008 Directive 2007/19/CE of the Council dated 30 March 2007 Directive 2005/79/CE of the Council dated 18 November 2005 Directive 2004/19/CE of the Council dated 10 March 2004 Directive 2004/1/CE of the Council dated 6 January 2004 Regulation (UE) 10/2011 of the Council dated 14 January 2011

#### ROHS and WEEE

Directive 2011/95/EC of the European Parliament and of the Council of 8th June 2011  
Directive 2002/96/EC of the European Parliament and of the Council of 27th January 2003

#### REACH

Regulation (CE) n. 1907/2006 of the European parliament and council dated 18 December 2006 concerning the recording, evaluation, authorisation and restriction of the chemical substances (REACH), which establishes a European Agency regarding chemical substances, which modifies the Directive 1999/45/CE and that repeals the Regulation (CEE) n. 793/93 of the Council and the regulation (CE) n. 1488/94 of the Commission 91/155/CEE, 93/105/CE and 2000/21/CE

#### SUBSTANCES THAT REDUCE THE OZONE LAYER

Regulation (CE) N. 1005/2009 dated 16 September 2009 (Official Journal (OJ) of the European Union 31/10/2009 L286)  
According to the requirements set by Directives: 2006/95/EC, 2004/108/EC, 2006/42/EC, 97/23/EC

The person authorised to draw-up the Technical Folder is Mr. **Minelli Maurizio** (Technical Department Manager)  
Via del Lavoro 5 - 06083 Bastia Umbra (PG)

Bastia Umbra: **02 / 11 / 2015**  
(place and date of issue)

Minelli Maurizio

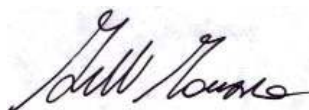

**ISABELLA LX**

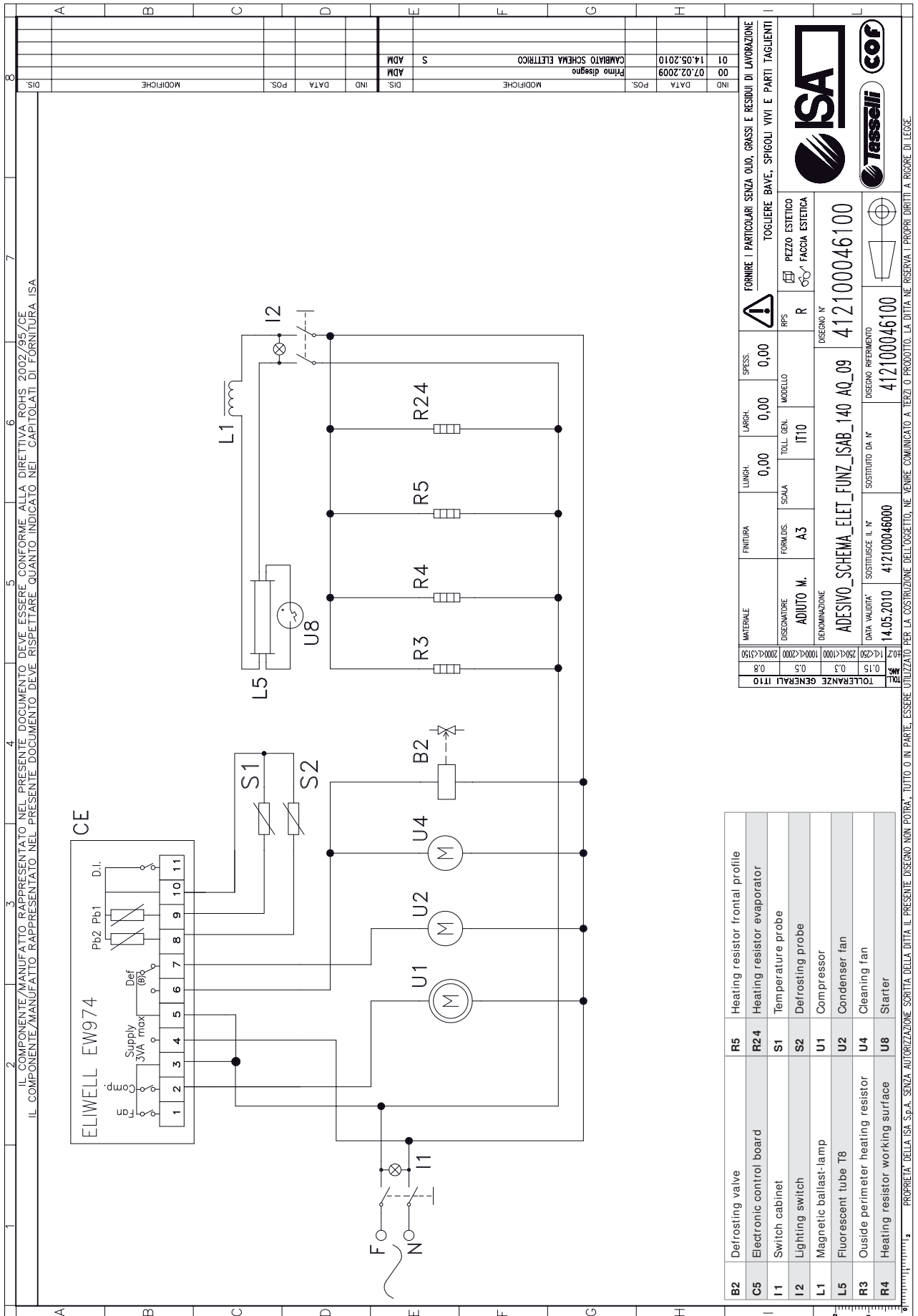

IL COMPONENTE/MANUFATTO RAPPRESENTATO NEL PRESENTE DOCUMENTO DEVE ESSERE CONFORME ALLA DIRETTIVA ROHS 2002/95/CE  
 IL COMPONENTE/MANUFATTO RAPPRESENTATO NEL PRESENTE DOCUMENTO DEVE RISPETTARE QUANTO INDICATO NEL CAPITOLATO DI FORNITURA ISA

B2	Defrosting valve	R5	Heating resistor frontal profile
C5	Electronic control board	R24	Heating resistor evaporator
I1	Switch cabinet	S1	Temperature probe
L1	Lighting switch	S2	Defrosting probe
L5	Magnetic ballast-lamp	U1	Compressor
R3	Fluorescent tube T8	U2	Condenser fan
R4	Outside perimeter heating resistor	U3	Cleaning fan
	Heating resistor working surface	U4	Starter
		U8	

MATERIALE	FINITURA	LUNGH.	LARGH.	SPESS.	FORMARE I PARTICOLARI SENZA QUO, GRASSI E RESIDUI DI LAVORAZIONE	
08		0,00	0,00	0,00	TOGLIERE BAVE, SPIGOLI VIVI E PARTI TAGLIANTI	
08					PEZZO ESTETICO	
08					FACCIA ESTETICA	
08					R	
08					DISEGNO N°	
08					412100046100	
08					DISEGNO RIFERIMENTO	
08					412100046100	
08					SOSTITUISCE IL N°	
08					412100046000	
08					SOSTITUITO DA N°	
08					412100046100	
08					DATA VALIDITA'	
08					14.05.2010	
08					TOLLERANZE GENERALI IT10	



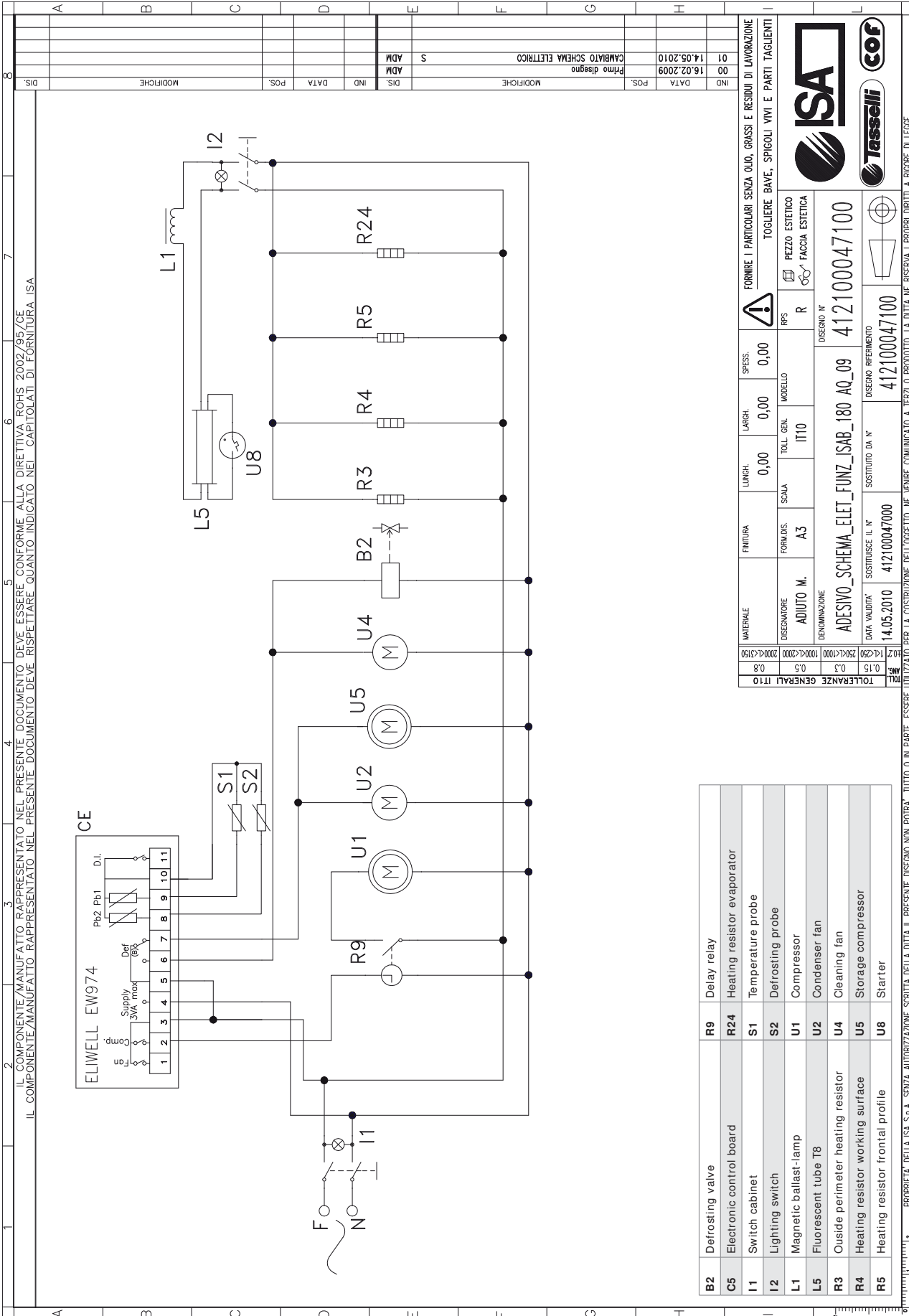

B2	Defrosting valve	R9	Delay relay
C5	Electronic control board	R24	Heating resistor evaporator
I1	Switch cabinet	S1	Temperature probe
I2	Lighting switch	S2	Defrosting probe
L1	Magnetic ballast-lamp	U1	Compressor
L5	Fluorescent tube T8	U2	Condenser fan
R3	Outside perimeter heating resistor	U4	Cleaning fan
R4	Heating resistor working surface	U5	Storage compressor
R5	Heating resistor frontal profile	U8	Starter

NO	DATA	POS.	MODIFICHE
00	16.02.2009		Primo disegno
01	14.05.2010	S	CAMBIATO SCHEMA ELETTRICO
MODIFICHE			
DIS.	IND.	DATA	POS.
MODIFICHE			

  

MATERIALE	FINITURA	LUNGH.	LARGH.	SPESS.	FORNIRE I PARTICOLARI SENZA OLIO, GRASSI E RESIDUI DI LAVORAZIONE	
		0,00	0,00	0,00	TOGLIERE BAVE, SPIGOLI VIVI E PARTI TAGLIANTI	
DESCRIZIONE	ADULTO M.	FORM.DIS.	SCALA	TOLL. GEN.	MODELLO	RFS
		A3		IT10		
DENOMINAZIONE		DISEGNO N°				
ADESIVO_SCHEMA_ELET_FUNZ_ISAB_180_AQ_09		412100047100				
DATA VALIDITA'	SOSTITUISCE IL N°	DISEGNO RIFERIMENTO				
14.05.2010	412100047000	412100047100				
TOLLERANZE GENERALI IT10						
0,15	0,3					
0,2	0,5					
0,3	1					

PROPRIETA' DELLA ISA S.p.A. SENZA AUTORIZZAZIONE SCRITTA DELLA DITTA IL PRESENTE DISEGNO NON POTRA' TUTTO O IN PARTE, ESSERE UTILIZZATO PER LA COSTRUZIONE DELL'OGGETTO, NE VENIRE COMUNICATO A TERZI O PRODOTTO. LA DITTA NE RISERVA I PROPRI DIRITTI A RIGORE DI LEGGE.

ISABELLA LX



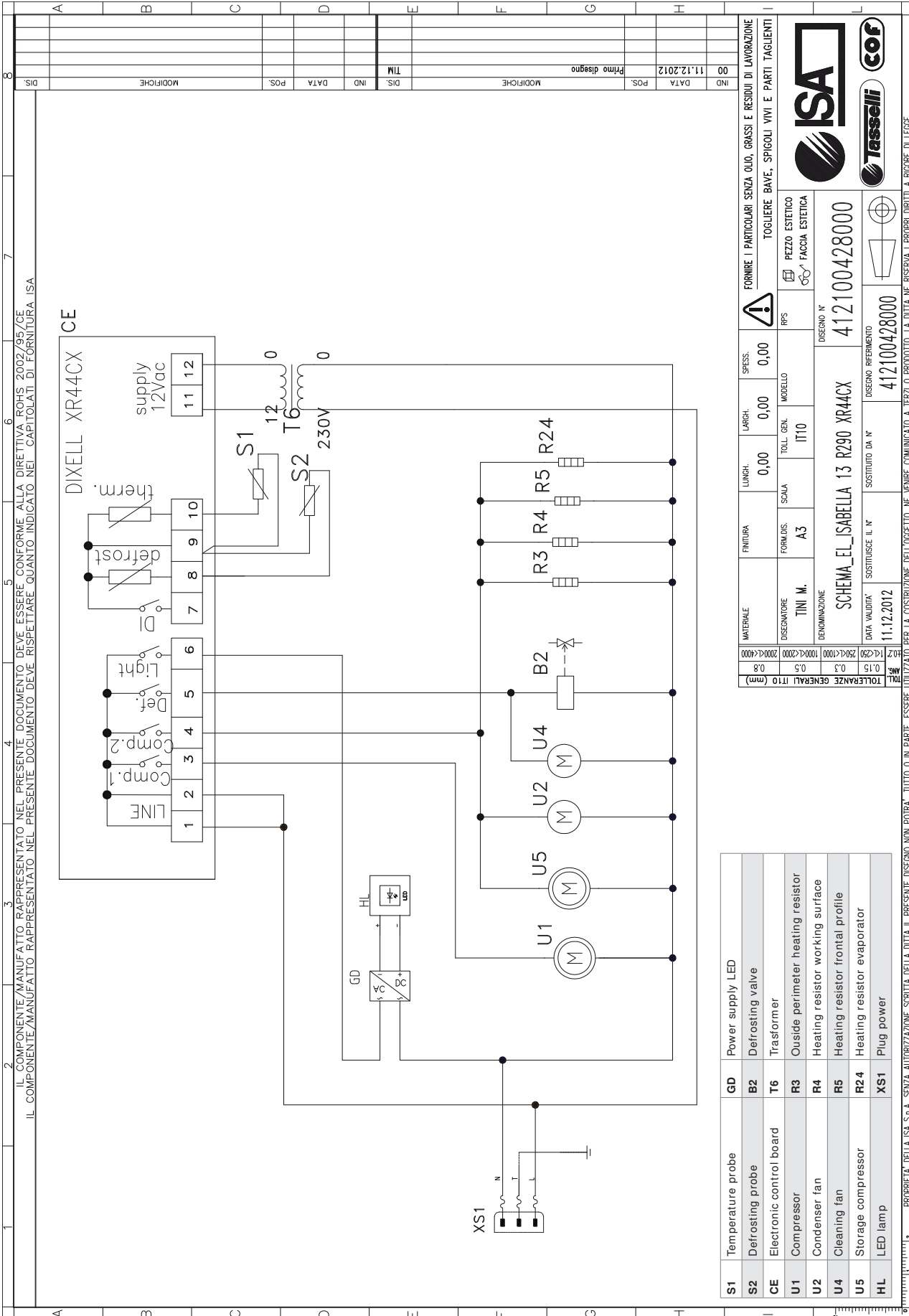

MATERIALE	FINITURA	LARGH.	SPES.	FORMARE I PARTICOLARI SENZA OLIO, GRASSI E RESIDUI DI LAVORAZIONE	
DESCRIZIONE	FORMIDIS.	TOLL. GEN.	0,00	0,00	TOGLIERE BAVE, SPIGOLI VIVI E PARTI TAGLIANTI
TINI M.	A3	SCALA	IT10	PEZZO ESTETICO	
DENOMINAZIONE		DISEGNO N°			
SCHEMA_EL_ISABELLA 13 R290 XR44CX		412100428000			
DATA VALIDITA'	SOSTITUISCE IL N°	DISEGNO RIFERIMENTO		RFS	
11.12.2012	412100428000	412100428000		FACCA ESTETICA	
TOLLERANZE GENERALI		PROPRIETA' DELLA ISA S.p.A. SENZA AUTORIZZAZIONE SCRITTA DELLA DITTA IL PRESENTE DISEGNO NON POTRA' TUTTO O IN PARTE, ESSERE UTILIZZATO PER LA COSTRUZIONE DELL'OGGETTO, NE VENIRE COMUNICATO A TERZI O PRODOTTO. LA DITTA NE RISERVA I PROPRI DIRITTI A RIGORE DI LEGGE.			
IT10	0,8				
0,5	1000<2000				
0,3	200<1000				
0,15	120				

S1	Temperature probe	GD	Power supply LED
S2	Defrosting probe	B2	Defrosting valve
CE	Electronic control board	T6	Trasformer
U1	Compressor	R3	Outside perimeter heating resistor
U2	Condenser fan	R4	Heating resistor working surface
U4	Cleaning fan	R5	Heating resistor frontal profile
U5	Storage compressor	R24	Heating resistor evaporator
HL	LED lamp	XS1	Plug power





### Attachment 8 - INSTALLATION BAR SUPPORT TRAYS 5 liters

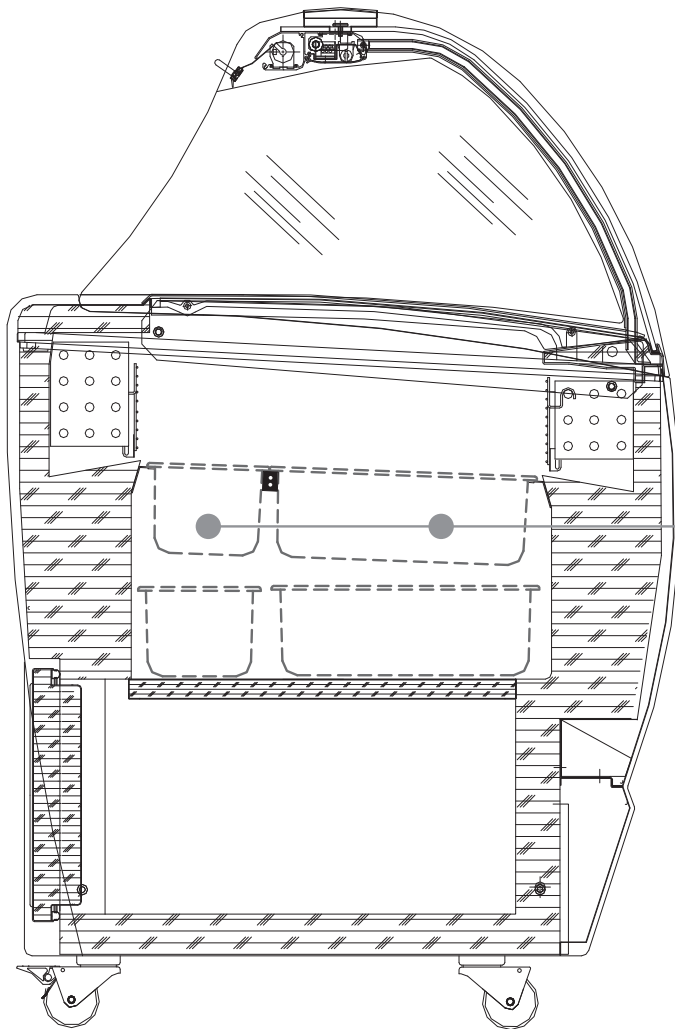

lt 5  
(360x165x120H)

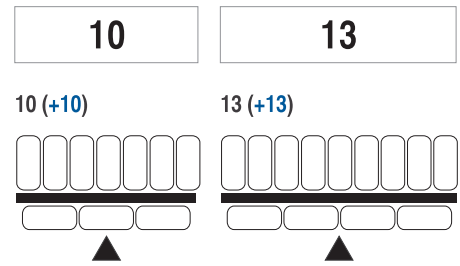
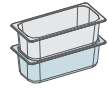

▲ SIDE SERVICE

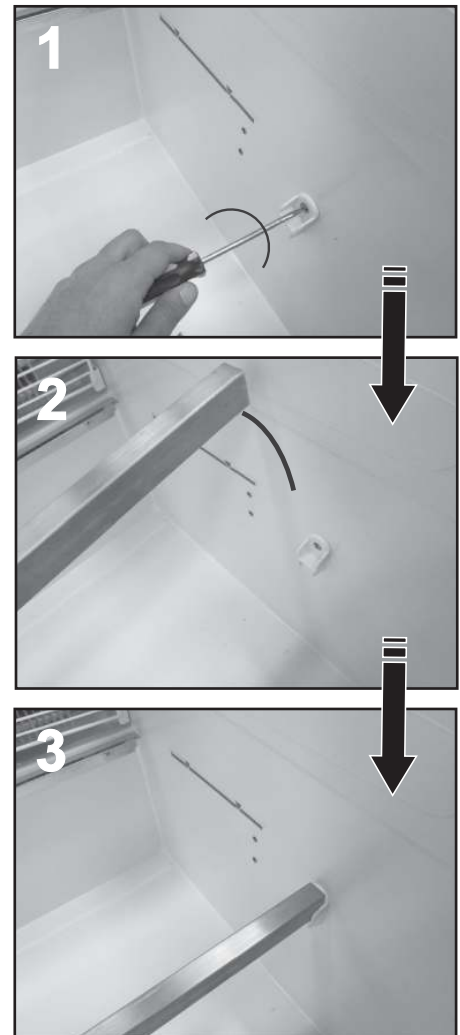

Attachment 9 - INSTALLATION BAR SUPPORT TRAYS 4.75 liters

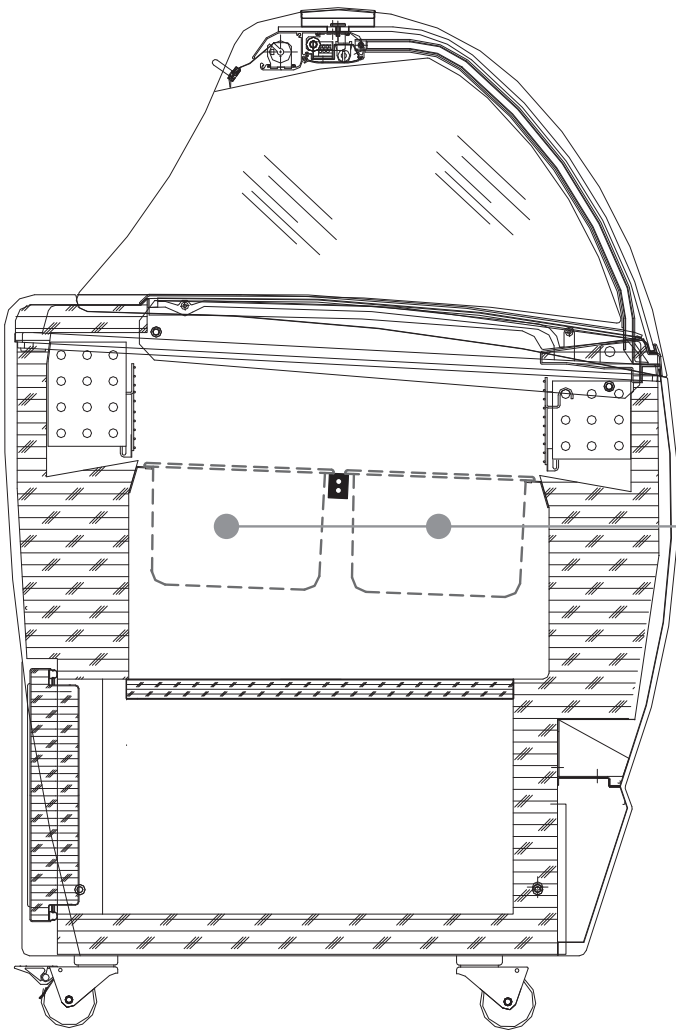

lt 4.75  
(260x157x170H)



<b>10</b>	<b>13</b>
14	18

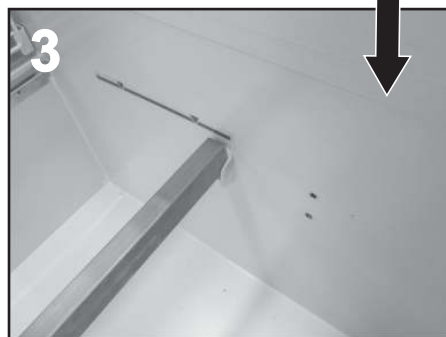
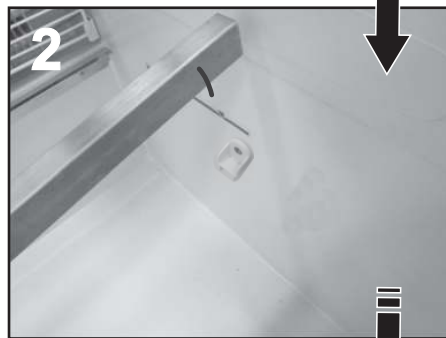
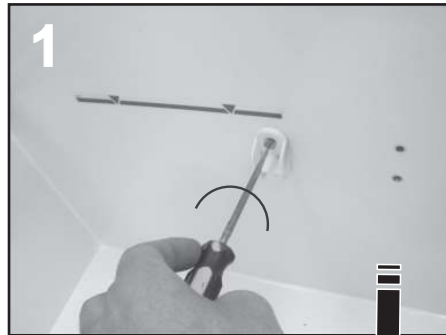





**ISA S.r.l.**

Via del Lavoro, 5

06083 Bastia Umbra

Perugia - Italy

Tel. +39 075 80171

Fax +39 075 8000900

**[www.isaitaly.com](http://www.isaitaly.com)**